

# General Specifications

Model SC450  
Conductivity / Resistivity Analyzer

**EXAxt**

The EXAxt 450 series is designed to combine the superior functionality of the Yokogawa EXA series with the ease of use offered in pocket computers (PDA).

Truly unique is the EXAxt 450 series in the Human Machine Interface. The high resolution graphical display and the touch screen operation make all information visible to the operator. Configuration with the touch screen is as easy as operating a PDA. Simply choose the language of choice and on screen instructions assure that the best configuration for the application is obtained.

The EXAxt 450 offers full functionality with PID control on either mA output(s) or on contact output(s). The contact outputs can be selected as pulse frequency controlled or pulse length controlled contact function to control chemical metering pumps or solenoid valves.

The EXA450 is a family of SMART analyzers: In addition to the two mA outputs a digital HART® signal is superimposed on mA1. This signal supplies up to four process variables and many diagnostic data. This information can be used to generate additional current and contact outputs in the HIM monitor and in maintenance optimisation programs like PRM or AMS. Pactware can be downloaded from Yokogawa WEB pages to enable the user to configure SC450 with a PC.

The SC450 offers the best accuracy in the industry by combining the conductivity measurement with advanced temperature compensation functionality, preloaded calibration standards and cell fouling monitoring.

The EXAxt SC450 is universal. The analyzer accepts sensors with cell constants ranging from 0,005 till 50/cm; 2-electrode sensors as well as 4-electrode sensors; 5 different temperature compensating elements for accurate temperature compensation.

The SC450 offers ultra pure water compensation for demineralised water (default: NaCl), for Steam, Condensate and Boiler water analysis (Cation Conductivity, Ammonia and Morpholine Conductivity) SC450 also offers Matrix compensation and output linearization for accurate analysis of strong acids and alkalis especially for the monitoring of ultra pure water in the pharmaceutical industry the functionality of USP chapter 645, first published in USP23, is implemented.



## Features

- IP66/NEMA4X 1/2DIN enclosure for Field mounting and Panel mounting.
- Unique HMI with menu structure and high resolution graphical display with touch screen
- Interactive display with choice out of 6 languages: English, French, German, Italian Spanish and Swedish.
- Trending display for up to 2 weeks.
- On-screen logbooks store calibration data, configuration changes and events
- Advanced Process Temperature Compensation
- Cell fouling monitoring

## System Configuration

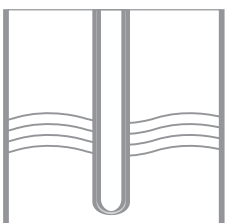

Sensors

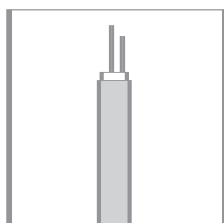

Cables

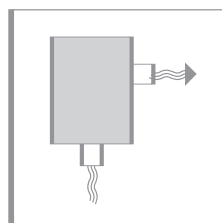

Fittings

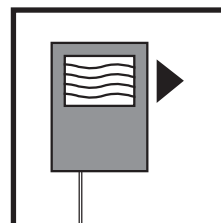

Transmitters

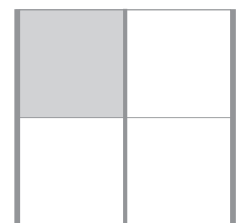

Accessories

## General Specifications of EXAxt SC450

**A. Input specifications:** Two or four electrodes measurement with square wave excitation, using max 60m (200ft) cable (WU40/WF10) and cell constants from 0.005 to 50.0 cm<sup>-1</sup>

### B. Input ranges

Conductivity : 0.000 µS/cm - 2000 mS/cm  
 Minimum : 1µS/cm (underrange 0.00 µS x C)  
 Maximum : 200 mS/cm (overrange 2000 mS x C)

Resistivity : 0.0 Ω x cm - 1000 MΩ x cm  
 Minimum : 5 Ω/cm (underrange 0.0 Ω/C)  
 Maximum : 1 MΩ/cm (overrange 1000 MΩ/C)

Temperature : Pt1000 -20 to 250°C (0-500°F)  
 : Pt100 -20 to 200°C (0-400°F)  
 : Ni100 -20 to 200°C (0-400°F)  
 : NTC 8k55 -10 to 120°C (10-250°F)  
 : Pb36 (JIS NTC 6k) -20 to 120°C (0-250°F)

### C. Accuracy

Conductivity/resistivity: ≤ 0.5 % of reading  
 Temperature : ≤ 0.3°C (≤ 0.4°C for Pt100)  
 mA outputs : ≤ 0.02 mA  
 Ambient temperature influence : ± 0.05% /°C  
 Step respons : ≤ 4 sec for 90% (for a 2 decade step)

### D. Transmission signals

General : Two isolated outputs of 4-20 mA. DC with common negative. Maximum load 600Ω. Bi-directional HART® digital communication, superimposed on mA1 (4-20mA) signal.  
 Output Function : Linear or Non linear (21-step table) output for pH, temperature, ORP or rH.  
 Control function : PID control.  
 Burn out function : Burn up (21.0 mA) or burn down (3.6 mA) to signal failure acc. NAMUR NE43.  
 : Adjustable damping  
 : Expire time  
 Hold : The mA-outputs are frozen to the last/fixed value during calibration/commissioning

### E. Contact outputs

General : Four SPDT relay contacts with display indicators. Contact outputs configurable for hysteresis and delay time.  
 Switch capacity : Maximum values 100 VA, 250 VAC, 5 Amps.  
 Maximum values 50 Watts, 250 VDC, 5 Amps.  
 Status : High/Low process alarms, selected from conductivity, resistivity, concentration or temperature. Configurable delay time and hysteresis. PID duty cycle or pulsed frequency control.  
 FAIL alarm  
 Control function : On / Off  
 : Adjustable damping  
 : Expire time  
 Hold : Contact can be used to signal the hold situation.  
 Fail safe : Contact S4 is programmed as fail-safe contact.

**F. Contact Input** : Remote range switching to 10 times the programmed range.  
 - Contact open : If impedance > 100 kΩ: Range 1  
 - Contact closed : If impedance < 10 Ω: Range 2 (10 x Range 1)

### G. Temperature compensation

: Automatic or manual, for temperature ranges mentioned under C (inputs).  
 - Reference temp. : programmable from 0 to 100°C or 30 - 210 °F (default 25°C).

### H. Compensation algorithm

: According IEC 746-3 NaCl tables (default).  
 Two independent user programmable temperature coefficients, from 0% to 3.5% per °C (°F) by adjustment or calibration.  
 Matrix compensation : With conductivity function of concentration and temperature. Choice out of 13 preprogrammed matrixes and 2 100-points user-programmable matrices.

### I. Calibration

: Semi-automatic calibration using pre-configured OIML (KCl) buffer tables, with automatic stability check. Manual adjustment to grab sample.

### J. Logbook

: Software record of important events and diagnostic data readily available in the display or through HART®.

### K. Display

: Graphical Quarter VGA (320 x 240 pixels) LCD with LED backlight and touchscreen. Plain language messages in English, German, French, Spanish, Italian and Swedish.

### L. Shipping details

Package size : 293 x 233 x 230 mm (L x W x D)  
 (11.5 x 9.2 x 9.1 inch)  
 Package weight : app. 2.5 kg (5.5lbs)

### M. Housing

: Cast aluminium case with chemically resistant coating, cover with flexible polycarbonate window. The colour of the case and cover is silvergrey. Cable entry via six M20 polyamide glands. Cable terminals are provided for up to 2.5 mm<sup>2</sup> finished wires. Weather resistant to IP66 and NEMA4X standards. Note that the glands must be installed properly. Pipe, wall or panel mounting, using optional hardware.

### N. Power supply

: 85-265 VAC (±10%). Max 10VA, 47-63Hz, 9,6-30 VDC (±10%), max 10W

### O. Regulatory compliance

EMC : Meets directive 89/336/EEC  
 Emission conform EN 55022 class A  
 Immunity conform IEC 61326-1  
 Low Voltage : Meets directive 73/23/EEC Conform IEC 61010-1, UL61010C-1 and CSA 22.2 No. 1010.1, Installation category II, Pollution degree 2

FM Class 1, Div. 2, Group ABCD, T<sub>6</sub>  
 for T<sub>a</sub> -20 to 55°C  
 Certification for CCSAus, Kema Keur

 **Zoom screen**

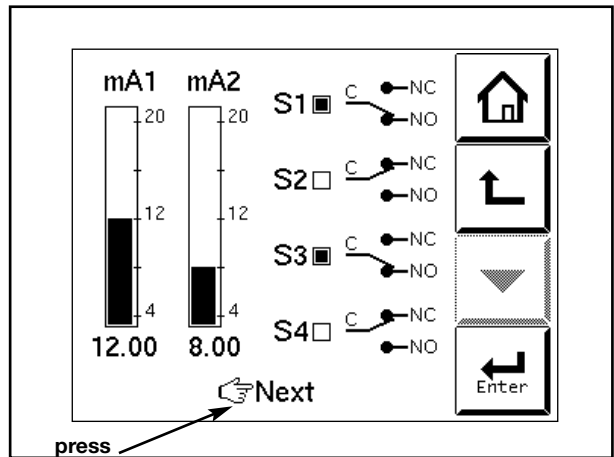

The zoom screen displays an easy graphic representation of the output functions. When "next" is pressed it will give access to the logbook data.

**P. Environment and operational conditions**

- Ambient temperature : -20 to +55°C
- Storage temperature : -30 to +70°C
- Humidity : 0 to 90% RH (non-condensing)
- Data protection : EEPROM for configuration data and logbook. Lithium cell for clock.
- Watchdog timer : Checks microprocessor.
- Power down : Reset to measurement.
- Automatic safeguard : Auto return to measuring mode when touchscreen is untouched for 10 min.

**Display and Operating Interface**

The Display is a backlight graphical display with QVGA resolution. Operation is done by a touchscreen. Graphical keys on the right and other area's of the touchscreen respond to contact as virtual push buttons.

**Main screen**

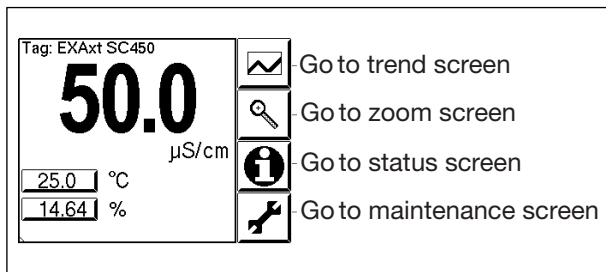

**The main screen displays:**

- The primary variable in large font (user selectable)
- Other process variable(s) in small font
- Unit symbols
- Tagnumber (user programmable)
- Process description (user programmable)
- Status of contact output(s)
- Status indicator during HOLD and WASH situation
- Main function keys

 **Trend screen**

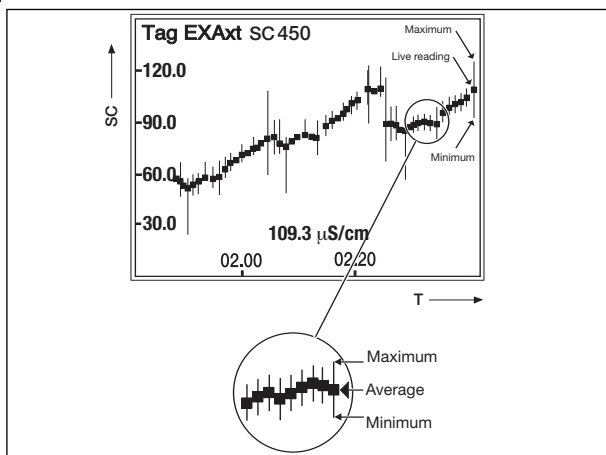



**The trendscreen displays:**

- Time scale. User selectable (between 15 minutes and 2 weeks)
- PV scale. User selectable
- TAG number
- Actual PV
- Average, maximum and minimum PV in this interval (time scale / 51)

 **Status screen**

The Status screen gives access to diagnostic information with regards to analyzer or sensors.

-  No malfunction detected.
-  Soft alarm detected. Maintenance is recommended for best accuracy.
-  Hard alarm is detected indicating malfunction that is critical for good analysis. When this key is pressed details are displayed with regards to detected malfunction and troubleshooting guidelines are displayed to resolve the malfunction.

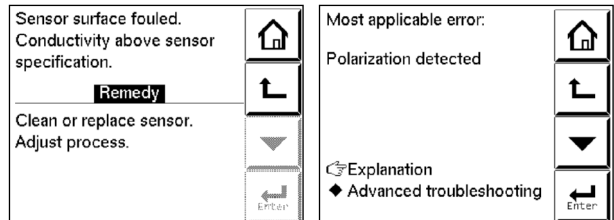

 **Maintenance screen**

The maintenance screen gives access to calibration, commissioning and setup of the instrument. These levels can be protected by passwords.

**Example**

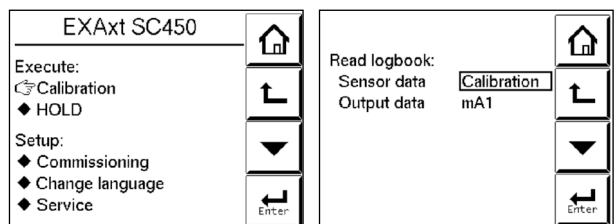

## Functionality Characteristics

### Safe Operation

EXAxt450 features BURN-OUT functionality according to NAMUR Recommendation 43. This document recommends using the mA output for fault detection by controlling the mA output in the following way:

- 4-20 mA scaled to measuring range
- 3,8 -4 mA for underflow detection
- 20- 20,5 mA for overflow detection
- =<3,6 mA for fault detection
- =>21 mA for fault detection

### Input Circuitry

The conductivity is measured with a square wave AC signal across the sensor with a frequency that is automatically adapted to the conductivity value to minimize the influence of system capacitance and electrode polarization. The conductivity is measured with 4-wire method to eliminate the influence of cable length.

This results in an accurate measurement over a wide range of conductivity values in combination with many sensors.

### Process Temperature Compensation

EXAxt 450 offers automatic temperature compensation and to ensure full compatibility with most commercially available conductivity sensors. Selection is possible out of five different temperature sensing elements. All elements have been calibrated during initialization of the analyzer. The default configuration of the SC450 uses Pt1000 RTD for temperature compensation.

The temperature compensator is used to correct for the influence of temperature on the conductivity of the process fluid. The analyzer readings are at reference temperature: 25°C unless programmed otherwise.

The default temperature compensation follows IEC 746-2 compensation algorithm for diluted solutions of NaCl in water. This default mode (NaCl) includes also compensation for the temperature influence on the dissociation of water molecules. This makes the default compensation mode ideal for salt solutions from ultra pure water up to concentrated salt solutions.

SC450 offers two additional modes for advanced temperature compensation in processes where NaCl compensation does not offer the required accuracy:

1. Linear temperature coefficient setting
2. Matrix temperature compensation

### Linear temperature coefficient

This function is used when the water chemistry is unknown. Therefore the temperature coefficient is determined empirically by taking a sample, reading the conductivity and temperature at two different temperatures. The TC to be programmed is defined as % per /°C.

This coefficient is calculated from two uncompensated measurements at different temperatures and can be calculated with the following equation:

$((SC1 - SC2) / (T1 - T2)) \times 100 / SC2$  in which (T2, SC2) is the measurement at reference temperature.

### Matrix temperature compensation

This function is used when the empirical method has shown that the temperature coefficient varies within the measuring range of the analyzer. Then a Matrix is built of 100 points, where the conductivity of 10 different samples is recorded for 10 different temperatures.

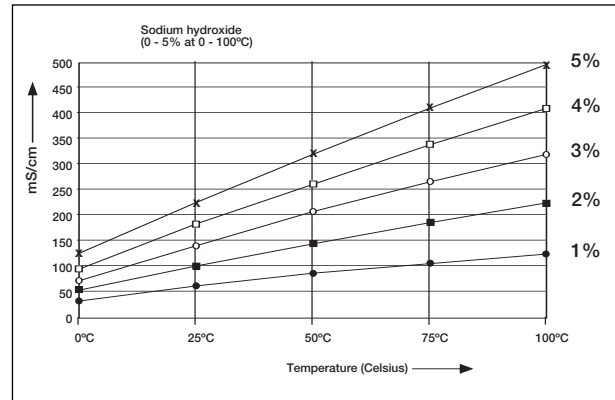

### Matrix temperature compensation

The SC450 is equipped with a matrix type algorithm (conductivity as a function of concentration and temperature) for accurate temperature compensation in various applications.

These are:

1. Ammonia in water: 0- 50 ppb @ 0- 90°C (boiler feed water, condensate)
2. Ammonia in water: 15- 30 % @ 10- 50°C
3. Morpholine in water: 0- 500 ppb @ 0- 90°C (boiler feed water, condensate)
4. Sulfuric Acid in water: 0<sup>2</sup>- 27% @ 0- 100°C
5. Sulfuric Acid in water: 39- 85% @ -18- 116°C
6. Sulfuric Acid in water: 93- 100% @ 10- 90°C
7. Sodium Hydroxide in water: 0<sup>1</sup>- 15% @ 0- 100°C
8. Sodium Hydroxide in water: 25- 50 % @ 0- 80°C
9. Hydrochloric Acid in water: 0- 200 ppb @ 0- 100°C (Cation conductivity)
10. Hydrochloric Acid in water: 0<sup>1</sup>-18% @ -10- 65°C
11. Hydrochloric Acid in water: 24- 44% @ -20- 65°C
12. Nitric Acid in water: 0<sup>2</sup>- 25% @ 0- 80°C
13. Nitric Acid in water: 35- 88% @ -16- 60°C

<sup>1</sup> Although range is 0 - 25%

<sup>2</sup> Compensation range

In addition a free programmable matrix can be selected for applications not covered by these standard ones. Measurement outside the range of the matrix is possible, but can result in inaccuracies dependent on the chemistry of the electrolyte solution.

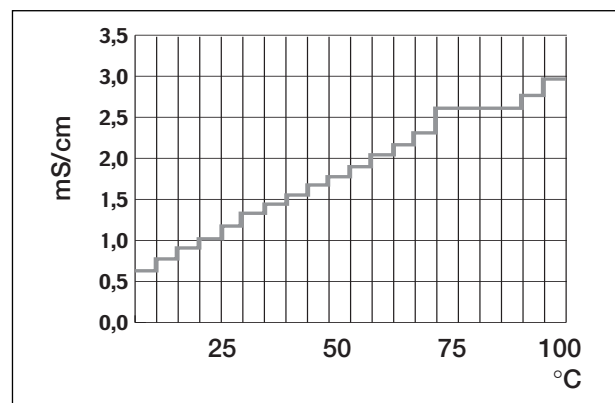

### WFI monitoring according to USP<645> directives.

First published in USP23 is the directive for on-line monitoring of water for injection using Conductivity Analyzers. In this standard the purity of the water is classified in 3 levels, of which the first

level is monitored by Conductivity Analysis. If the conductivity exceeds the limit, then the user must perform laboratory analysis to verify the quality of the WFI. SC450 has the limits of USP built in the firmware and as soon as the water quality does not meet the requirement of step 1, a fault message is generated; this information can be transmitted through HART®, contact output or High/Low mA output according to NAMUR recommendation 43. It is also possible to program a contact output to close when a preset safety margin is exceeded. The USP functionality is independent on the chosen conductivity range for the mA outputs. The functionality is active in both Conductivity and Resistivity mode.

**Electrode selection**

In order to make precise conductivity measurements, there are a number of prerequisites. Most important is the selection of suitable sensors. Special attention should be paid to the choice of the sensors to ensure compatibility with both the chemical composition and the specific conductivity of the fluid to be measured. The installation of the sensor is also very important for a correct measurement. Other Yokogawa specification sheets cover the choice of sensors and holders, and any Yokogawa sales office can provide expert advice.

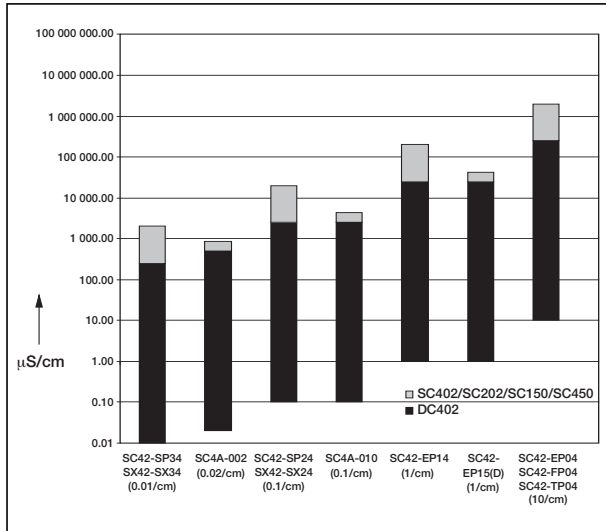

**Measuring range as function of the cell constant**

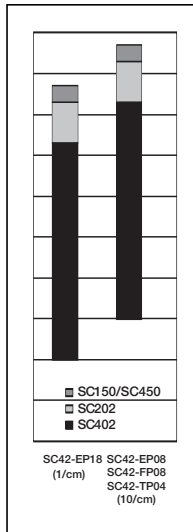

**Note:** With 2-electrode systems, polarization may decrease the conductivity value at higher concentrations. Applications using highly conductive fluids, inductive conductivity measurement should be considered as an alternative because of lower maintenance requirements.

**Output functions**

**Current Outputs**

The SC450 offers two isolated 4- 20 mA outputs for indication, recording or control functions. The parameter that is transmitted through the current output(s) can be selected out of:

- Conductivity or Resistivity
- Temperature
- Concentration
- PID control

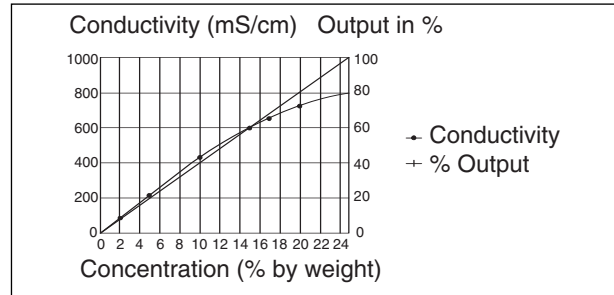

**Linearisation of output**

**Example: 0-25% Sulfuric acid**

**Example of Concentration measurement.**

The conductivity of a sulfuric acid solution is not linear to the concentration of the acid. Then the user selects TABLE in the Output configuration menu and a 21 point table is generated to linearize the output in concentration units.

Code Output	mA 4-20	Conc.	Example % H <sub>2</sub> SO <sub>4</sub>	Cond.	Example mS/cm
0	4.0		0		0
5	4.8		1.25		60
10	5.6		2.5		113
15	6.4		3.75		180
20	7.2		5		211
25	8.0		6.25		290
30	8.8		7.5		335
35	9.6		8.75		383
40	10.4		10		424
45	11.2		11.25		466
50	12.0		12.5		515
55	12.8		13.75		555
60	13.6		15		590
65	14.4		16.25		625
70	15.2		17.5		655
75	16.0		18.75		685
80	16.8		20		718
85	17.6		21.25		735
90	18.4		22.5		755
95	19.2		23.75		775
100	20.0		25		791

In addition the current output can be used to transmit a fault condition through the BURN OUT function and it can maintain the last measured value prior to maintenance or a fixed preset value using the HOLD function.

**Contact Outputs**

The SC450 offers four SPDT contact outputs. All contact outputs can be configured for Alarm and Control functions. Contact S1, S2 and S3 are in powered condition when the setpoint is exceeded. These contacts are normally used for HI, LO Alarm or Control functions. Contact S4 is in alarm condition when the power is down. This fail-safe contact is normally used to signal a fail situation.

**Control Function**

SC450 offers advanced process control. Each of the current outputs and the contact outputs can represent the PID control output.

If a contact is used for process control the contact output can be pulse length controlled or pulse frequency controlled.

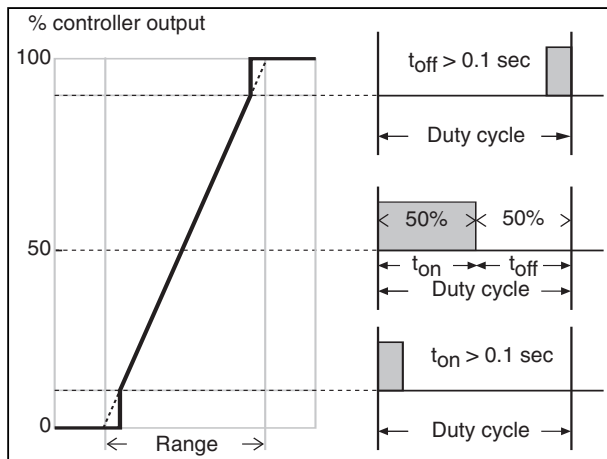

**Duty cycle control**

This type of control is normally used to operate solenoid valves or continuously operating dosing pumps. The period of the on/off cycle is selected between 1s and 30 minutes. The on/off ratio (duty cycle) is controlled by the PID control function

**Model and Suffix Codes**

Model	Suffix	Option	Description
SC450G			Conductivity/Resistivity transmitter
Power	- A		AC version (85...265 VAC)
	- D		DC version (9.6...30 VDC)
	- A		General purpose version
	- U		FM version
Options*		/ SCT**	Predefined Tagnumber (text only)
		/ UM	Universal Mounting kit (panel, pipe, wall)

\* /Q: Quality Inspection certificate is always included with the product.

\*\* If the tagnumber is predefined with the purchase, Yokogawa will inscript the tagplate with the specified tagnumber, and program the tagnumber in the transmitter.

**Spare Parts**

Part no.	Description
K1541KR	/PM panelmounting for EXA400/402
K1542KW	/U pipe/wall mounting for EXA
K1548FU	Flash loader kit
K1548MT	Tagplate blank EXAxt450
K1548MV	Glands M20 (6 pcs.)
K1548MW	Grommetset.
K1548UM	Universal mounting kit
K1548UQ	Calibration Certificate EXAxt450

GS 12D7B5-E-E

**Pulse frequency control**

This function is used when the chemical is dosed with pulsating dosing pumps, where each pulse represents a certain volume of reagent. The maximum number of pulses per minutes is selected, but must be between 1 and 70 pulses per minute. The frequency of pulses is determined by the PID function of the analyzer.

The Proportional Band, the Integral Time and the Derivative Function are set in the control menu of the analyzer.

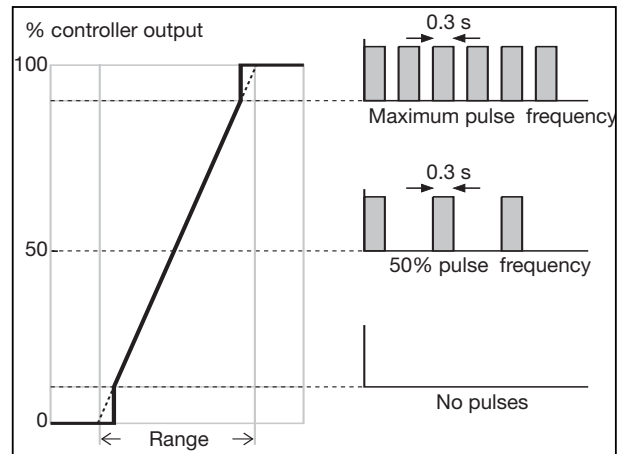

**Wiring Diagram**

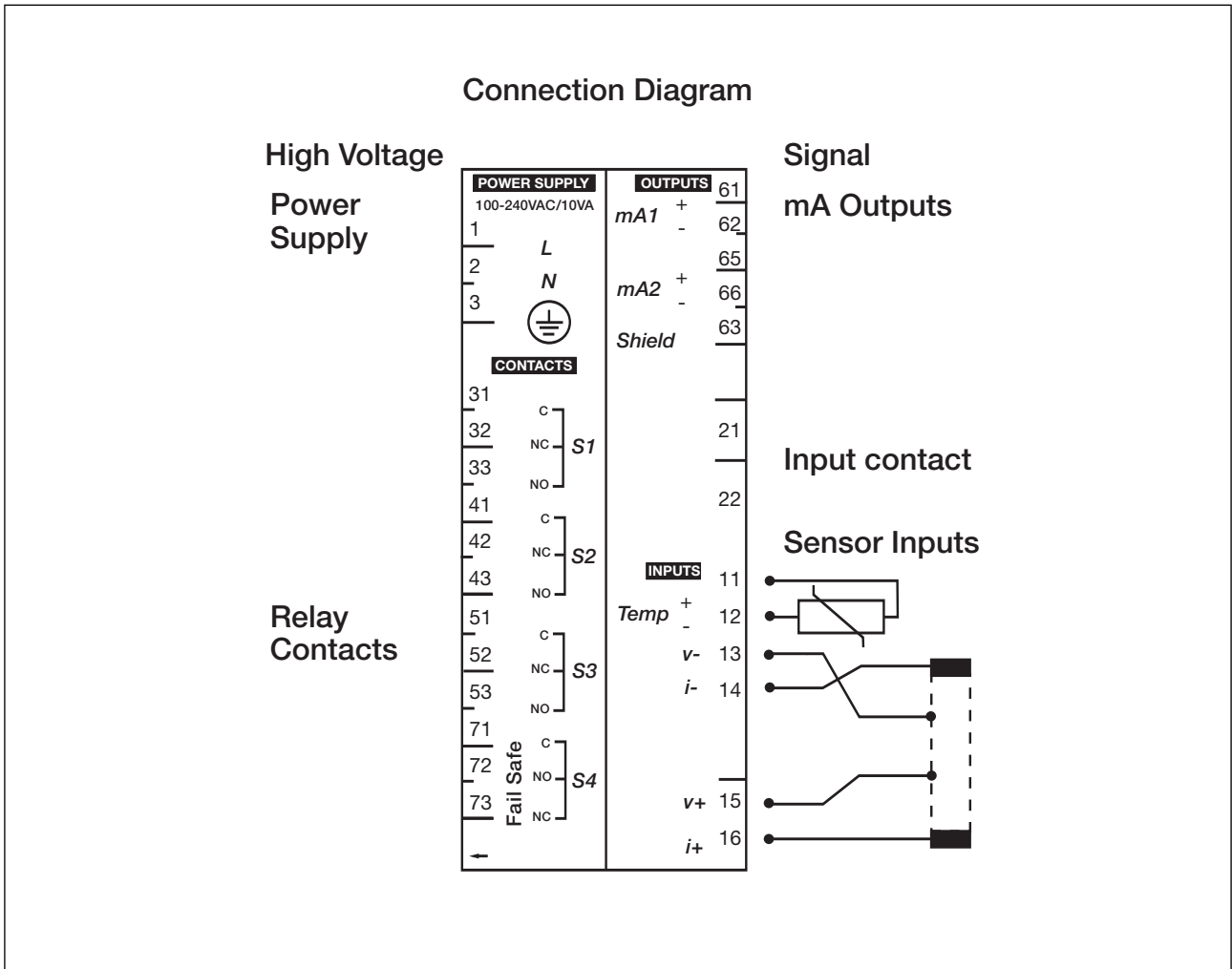

**Dimension and Mounting**

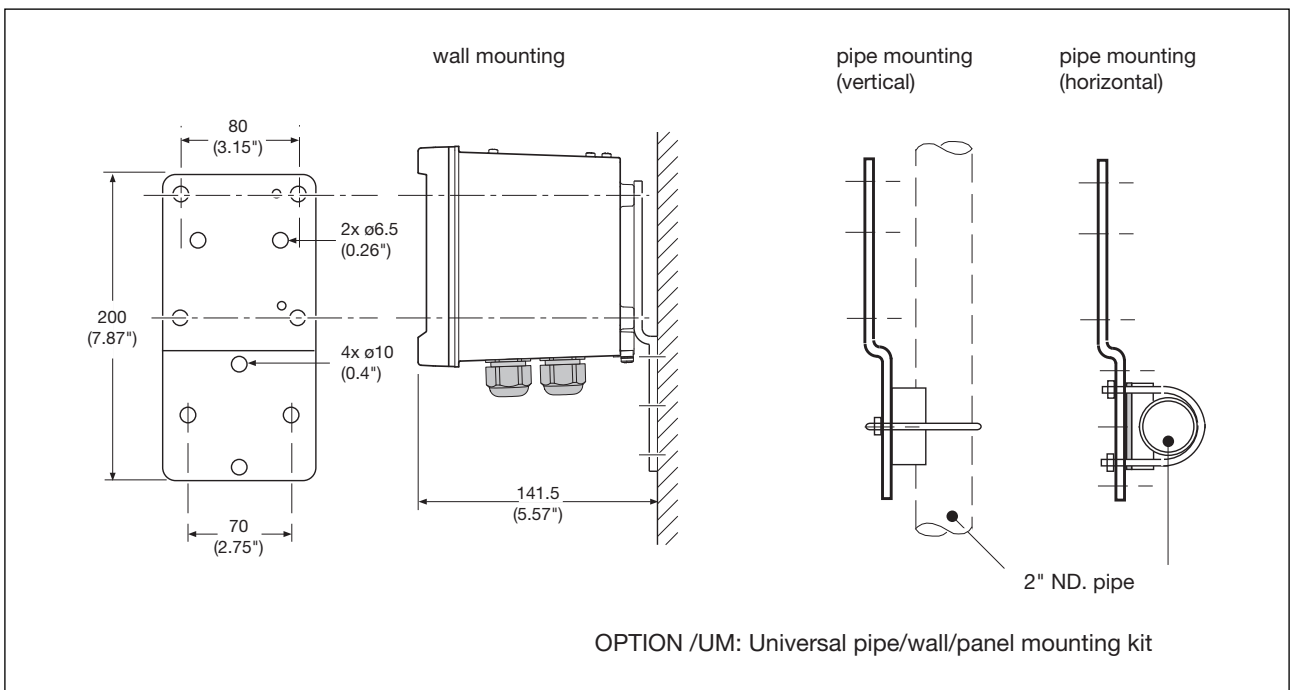

## Wall and pipe mounting diagram

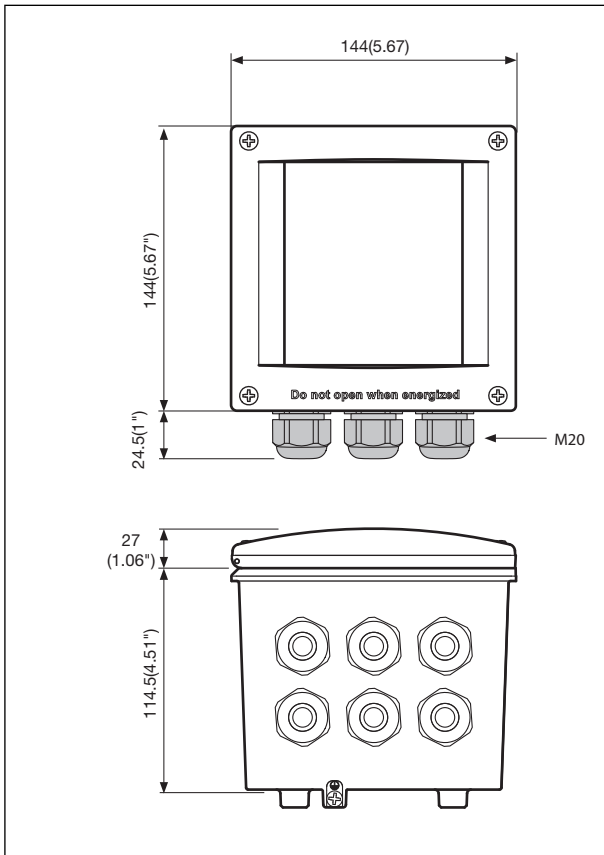

Housing dimensions and layout of glands

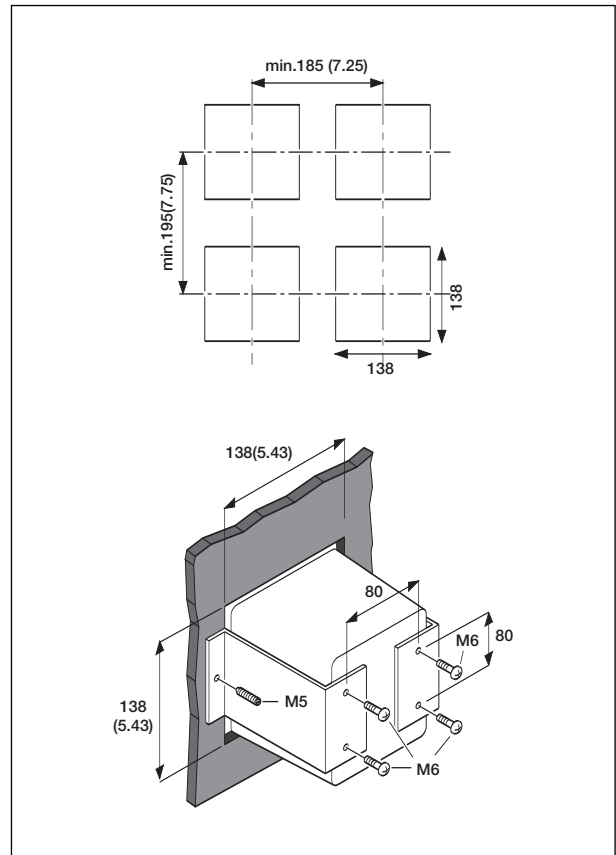

Option/UM. Universal mounting kit, panel mounting diagram

### YOKOGAWA HEADQUARTERS

9-32, Nakacho 2-chome,  
Musashinoshi  
Tokyo 180  
Japan  
Tel. (81)-422-52-5535  
Fax (81)-422-55-1202  
www.yokogawa.com

### YOKOGAWA CORPORATION OF AMERICA

2 Dart Road  
Newnan GA 30265  
United States  
Tel. (1)-770-253-7000  
Fax (1)-770-251-2088  
www.yokogawa.com/us

### YOKOGAWA EUROPE B.V.

Databankweg 20  
3821 AL AMERSFOORT  
The Netherlands  
Tel. +31-33-4641 611  
Fax +31-33-4641 610  
www.yokogawa.com/eu

### YOKOGAWA ELECTRIC ASIA Pte. Ltd.

5 Bedok South Road  
Singapore 469270  
Singapore  
Tel. (65)-241-9933  
Fax (65)-241-2606  
www.yokogawa.com/sg

Yokogawa has an extensive sales and distribution network. Please refer to the European website ([www.yokogawa.com/eu](http://www.yokogawa.com/eu)) to contact your nearest representative.



**YOKOGAWA** ◆

GS 12D7B5-E-E

Subject to change without notice  
Copyright©

Printed in The Netherlands, 02-605 (A) Q