

C L A M P O N P O W E R M E T E R

# CW120

S E R I E S

Clamp-on Power Meters

User-friendly features in a compact body.



**NEW**



#### Small size for installation in cubicles and inside distribution panels

- Size: 117×161×51 mm (W×H×D) Weight: Approximately 600 g

#### Support for a variety of connection types and CAT III 600 V

- CW120 covers single-phase 2-wire to three-phase 3-wire
- CW121 covers single-phase 2-wire to three-phase 4-wire
- Measurable voltages: Measurements possible on systems up to 495 V

#### Current clamps in a range of sizes (small to large diameter) for a variety of applications

- 50 A, 200 A, 500 A, 700 A, and 1000–3000 A current clamps

#### Support for large-capacity ATA flash memory

- TYPE II×1 flash ATA cards in compliance with PCMCIA PC Card Standard
- Enables measurements ranging from short time periods to extended time periods.

#### Sophisticated data management features

- The CW120 Series can be connected to a PC's RS-232 port to analyze data.
- Parameters setting tool (Toolbox) is included to set measurement conditions through a PC.

# Low-cost tools to support your energy conservation efforts

## Useful features for energy conservation and power measurement

- Periodically save data as often as once a second**  
 Data can be saved at 1-second interval at fastest. This capability allows the CW120 Series to respond quickly to load fluctuations and measure transient responses in equipment.
- Check equipment operating conditions**  
 The CW120 Series has an instantaneous value filing function (enabling multiple data records to be saved in a single file when multiple measurements are taken) which is useful for determining equipment operating conditions.
- Wiring error check function**  
 This function helps ensure that measurement operations do not fail.
- Simultaneous measurement of multiple facilities**  
 Multiple CW120 Series units can start and stop integration simultaneously through externally controlled I/O.
- Works even with small electric energy values**  
 Easily change the decimal position (the number of digits following the decimal point) and display unit (Wh, kWh, MWh, GWh) on the electric energy display.

### Model CW121-□-1

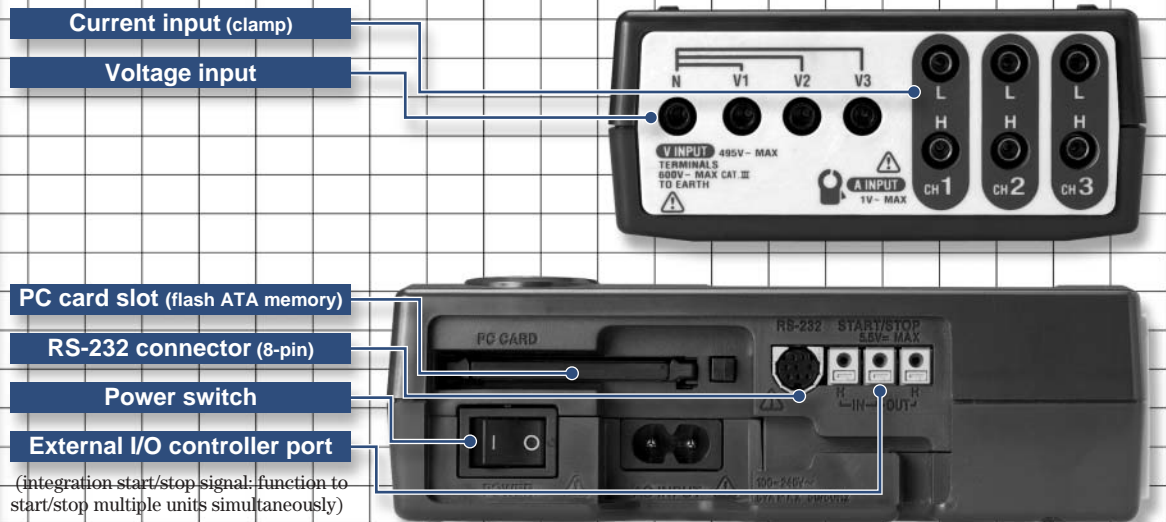

### Easy-to-recognize function icons

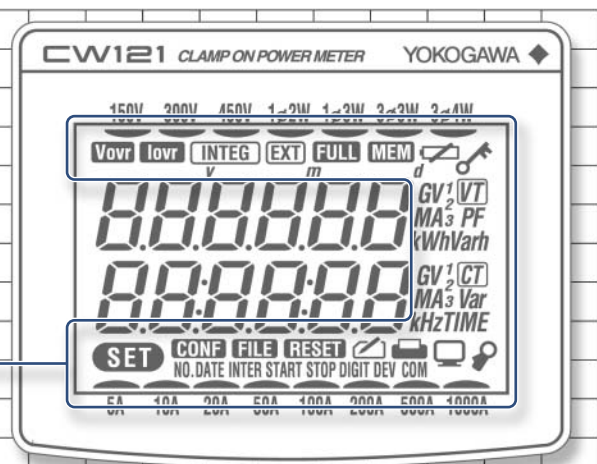

As energy conservation becomes increasingly important, we are pleased to present low-cost clamp-on power meters designed to meet user needs for simple tools capable of measuring power values and instantaneous values.

**Compact design**

- The CW120 Series is compact in size (117×161× 51mm (W×H×D)), making it ideal for installation in cubicles and inside distribution panels. Installation is even easier with the magnetic case (93023).
- Although the CW120 Series is small, it has a large backlit LCD.
- A new addition to the clamp lineup is a small-diameter current clamp (model 96033, capable of measurements in the range of 5–50 A) for measurements in tight spots and locations where many wires are jumbled together.



Current clamp (96033)

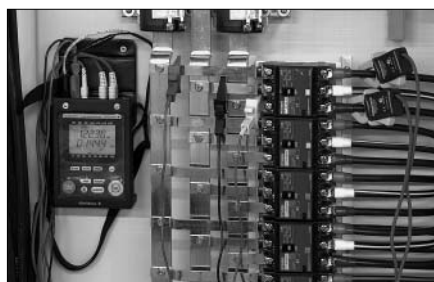

Magnetic case (93023)

**Measurements**

- The CW120 Series can be used for voltage measurements up to 495 V.
- A variety of connection types are supported, from single-phase 2-wire to three-phase 4-wire (CW120: three-phase 3-wire model; CW121: three-phase 4-wire model).
- Continuous measurement integration (accurate measurements can be obtained even if there are large load fluctuations)
- Plus/minus signs are shown for reactive power and power factor.
- The data saving interval can be set in the range of one second to one hour.

**Parameters setting tool (name: Toolbox)**

The setting software allows you to set CW120 Series measurement conditions through a PC and save measurement data on a PC when the unit is connected to the PC through RS-232 or RS-485 port.

- **Measurement conditions setting function**  
This function makes it easy to set basic functions needed for measurement, such as start/stop time and date, wiring method, clamp type, voltage, and current range etc.
- **File transfer function**  
The data file stored in CF pack can be transferred to PC. Microsoft Excel can read transferred data file.  
\* Toolbox is included as a standard feature (on two floppy disks).

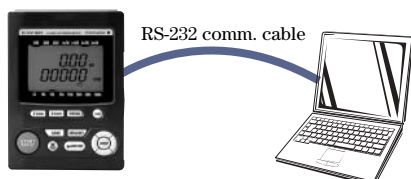

Microsoft, Windows, and Excel are trademarks or registered trademarks of Microsoft Corporation, the United States.

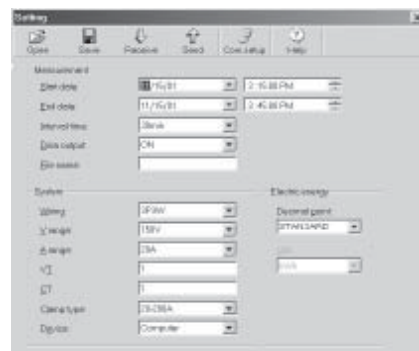

Setting screen

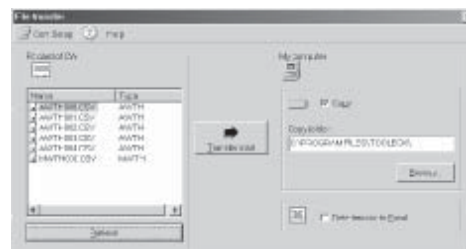

File transfer screen

### Data management and communication

- ① You can connect CW120 to a PC through special RS-232 cable.
- ② A printer (sold separately) can be connected through RS-232 cable to print measurement data.
- ③ If you have a media reader connected to your PC, measurement data and settings can be uploaded directly to a PC from CF pack.

Note : Max. measured data stored in a 16 MB CF pack

- (1) One year or more using three-phase 4-wire connection and 30-minute saving interval
- (2) Approximately 22 hours using three-phase 4-wire connection and one-second saving interval

\* Compact Flash cards with memory capacity up to 128 MB may be used (recommended brand: Sandisk).

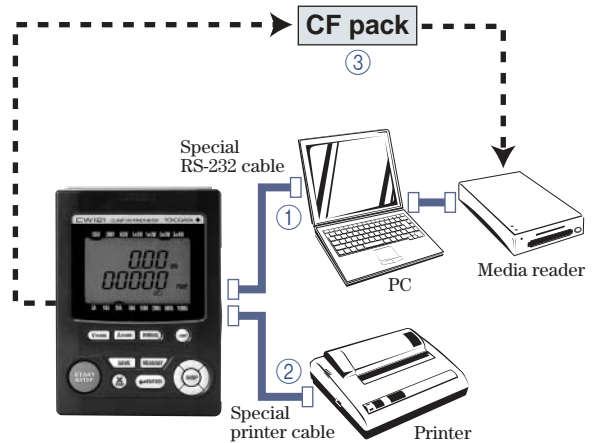

### Simultaneous measurement of multiple use

When performing measurement with multiple CW120, you can synchronously start and stop integration by connection external control terminal. (for RS-232 only, not provided for RS-485)

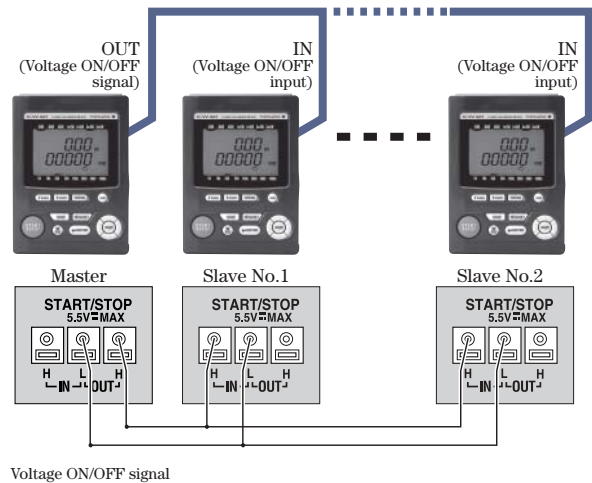

### Remote monitoring

The RS-485 allows multiple use to be connected for remote monitoring.

See the figure for the wiring of RS-485 cables (in two wire method) to connect a personal computer.

\* RS-485/RS-232 converter is required to connect the CW120/CW121-02 (RS-485 communication spec) to the RS-232 port on your PC. Recommended brand and model: our RS-232/RS-485 Converter Model ML1.

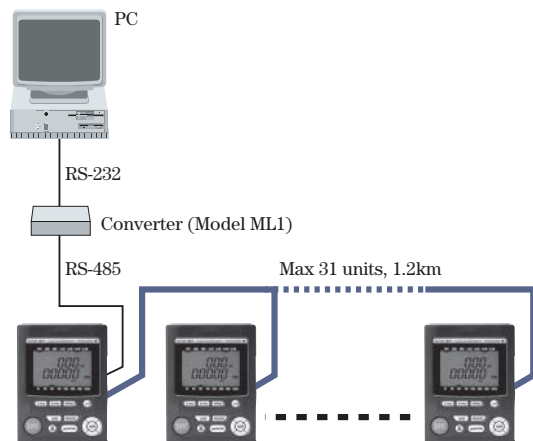

## Inputs

Parameter		Voltage (V)	Current (A)
Input type		Resistive potential division	Clamp detection
Rated value (range)		150/300/450 V	Clamp 96033: 5/10/20/50 A Clamp 96030: 20/50/100/200 A Clamp 96031: 50/100/200/500 A Clamp 96032: 200/500/1000 A
Wiring	CW120	Single-phase 2-wire, single-phase 3-wire, three-phase 3-wire	
	CW121	Single-phase 2-wire, single-phase 3-wire, three-phase 3-wire, three-phase 4-wire	
Input resistance	CW120	Approximately 1.5 MΩ	Approximately 100 MΩ
	CW121	Approximately 1.3 MΩ	
Maximum allowed input		495 Vrms	Clamp 96033: 130 Arms Clamp 96030: 250 Arms Clamp 96031: 625 Arms Clamp 96032: 1000 Arms
A/D converter		Voltage/current input simultaneous conversion, 12-bit resolution	

## Measurement Input functions

Parameter		Voltage	Current/active power
Method		Digital sampling	
Frequency range		45–65 Hz (reciprocal system), detected from V1	
Crest factor		150/300 V range	Rated input: 2
		450 V range	Rated input: 1.56
Active input range		10–110% of each range	
Display range	Lower limit	All ranges 1.5 V	0.4% of each range
	Upper limit	130% of each range, except 110% for 450 V range	130% of each range
Temperature coefficient		±0.05% mg/C	±0.07% mg/C (including clamp)
Display updating interval		Approximately one second	

## Instantaneous Value Measurement

- Measurement parameters: Voltage rms (V), current rms (A), active power (W), frequency (Hz)
- Measurement accuracy (at power factor 1, including clamp)
  - Voltage: ±(0.3% rdg + 0.2% rng)
  - Current/active power: ±(0.8% rdg + 0.4% rng) when using clamps 96030, 96031, and 96033  
±(1.2% rdg + 0.8% rng) when using clamp 96032
  - Frequency: ±(0.1% rdg + 1% dgt)
- Computation parameters: Reactive power (Var), power factor
- Computation accuracy: (value calculated from measurement) ±1 dgt
- Power factor influence:
  - ±1.0% mg cosφ = ±0.5 (relative to power factor 1) when using clamp 96030
  - ±2.0% mg cosφ = ±0.5 (relative to power factor 1) when using clamps 96031, 96032, and 96033
- Reactive factor influence:
  - ±1.0% mg sinφ = ±0.5 (relative to reactive factor 1) when using clamp 96030
  - ±2.0% mg sinφ = ±0.5 (relative to reactive factor 1) when using clamps 96031, 96032, and 96033

## Equations

- Voltage rms
 
$$V_{rms} = \sqrt{\frac{1}{T} \int_0^T v(t)^2 dt} = \sqrt{\frac{1}{T} \sum_{i=0}^T v(t)^2}$$
- Current rms
 
$$I_{rms} = \sqrt{\frac{1}{T} \int_0^T i(t)^2 dt} = \sqrt{\frac{1}{T} \sum_{i=0}^T i(t)^2}$$
- Active power
 
$$P = \frac{1}{T} \int_0^T v(t) \times i(t) dt = \frac{1}{T} \sum_{i=0}^T v(t) \times i(t)$$

Single-phase 3-wire, three-phase 3-wire  
Three-phase 4-wire

v(t), i(t): Input signals  
T: One period for input signal
- Reactive power and power factor

	Reactive power (*)	Apparent power	Power factor (*)
Single-phase 2-wire	$Q_i = \sqrt{((VA)^2 - P^2)}$	$VA = V \times A$	$P/VA$
Single-phase 3-wire	$Q_i = \sqrt{((VA_i)^2 - P_i^2)}$ i=1,2	$VA_i = V_i \times A_i$ i=1,2	ΣP/ΣVA
	$\Sigma Q = Q_1 + Q_2$	$\Sigma VA = VA_1 + VA_2$	
Three-phase 3-wire	$Q_i = \sqrt{((VA_i)^2 - P_i^2)}$ i=1,2	$VA_i = V_i \times A_i$ i=1,2	ΣP/ΣVA
	$\Sigma Q = Q_1 + Q_2$	$\Sigma VA = \sqrt{3}/2 (VA_1 + VA_2)$	
Three-phase 4-wire	$Q_i = \sqrt{((VA_i)^2 - P_i^2)}$ i=1,2,3	$VA_i = V_i \times A_i$ i=1,2,3	
	$\Sigma Q = Q_1 + Q_2 + Q_3$	$\Sigma VA = VA_1 + VA_2 + VA_3$	
Computation range	Rated value depends on V and A ranges.	Rated value depends on V and A ranges.	-1 ~ +1
Display resolution	Same as for active power.	Internal computation only; data not displayed or saved.	±1.000

Note 1: In the case of distorted waves and unbalanced inputs, there may be differences from other measuring instruments that are based on different measurement principles.

Note 2: \*The polarity determined by the reactive power meter method is multiplied and the polarity is displayed.

## Electric Energy Measurement

- Measured parameters:
  - Active electric energy, regenerative electric energy (regenerative electric energy is not displayed on the screen; it is merely saved)
- Measurement accuracy: Active power measurement accuracy ±1 dgt (with standard settings)
- Integration function settings
  - Start/stop settings: Manual, timer, external trigger (control)
  - Output intervals: 1/2/5/10/15/30 seconds; 1/2/5/10/15/30 minutes; 1 hour
- Displayed digits:
  - This is set automatically based on the rated power, and the minimum resolution can be set

## Saving items

•Saving items:

Voltage, current, active power, reactive power, power factor, frequency, active electric energy, regenerative electric energy

## Display Functions

- Display screen: Backlit segmented LCD
- Maximum number of displayed digits: 6 digits
- Electric energy: 6 digits
- Other parameters: 4 digits
- Range makeup: (rated values)

Voltage	Wiring	Clamp 96033								Clamp 96030		Clamp 96031		Clamp 96032			
		5.000 A	10.00 A	20.00 A	50.00 A	100.0 A	200.0 A	500.0 A	1.000 kA	100.0 A	200.0 A	500.0 A	1.000 kA	100.0 A	200.0 A	500.0 A	1.000 kA
150.0V	1φ2W	750.0 W	1.500 kW	3.000 kW	7.500 kW	15.00 kW	30.00 kW	75.00 kW	150.0 kW								
	1φ3W	1.500 kW	3.000 kW	6.000 kW	15.00 kW	30.00 kW	60.00 kW	150.0 kW	300.0 kW								
	3φ3W	1.500 kW	3.000 kW	6.000 kW	15.00 kW	30.00 kW	60.00 kW	150.0 kW	300.0 kW								
	3φ4W	2.250 kW	4.500 kW	9.000 kW	22.50 kW	45.00 kW	90.00 kW	225.0 kW	450.0 kW								
300.0V	1φ2W	1.500 kW	3.000 kW	6.000 kW	15.00 kW	30.00 kW	60.00 kW	150.0 kW	300.0 kW								
	1φ3W	3.000 kW	6.000 kW	12.00 kW	30.00 kW	60.00 kW	120.0 kW	300.0 kW	600.0 kW								
	3φ3W	3.000 kW	6.000 kW	12.00 kW	30.00 kW	60.00 kW	120.0 kW	300.0 kW	600.0 kW								
	3φ4W	4.500 kW	9.000 kW	18.00 kW	45.00 kW	90.00 kW	180.0 kW	450.0 kW	900.0 kW								
450.0V	1φ2W	2.250 kW	4.500 kW	9.000 kW	22.50 kW	45.00 kW	90.00 kW	225.0 kW	450.0 kW								
	1φ3W	4.500 kW	9.000 kW	18.00 kW	45.00 kW	90.00 kW	180.0 kW	450.0 kW	900.0 kW								
	3φ3W	4.500 kW	9.000 kW	18.00 kW	45.00 kW	90.00 kW	180.0 kW	450.0 kW	900.0 kW								
	3φ4W	6.750 kW	13.50 kW	27.00 kW	67.50 kW	135.0 kW	270.0 kW	675.0 kW	1.350 MW								

## Communication Functions

- Electrical specifications: Conforms to EIA RS-232 or EIA RS-485.
- Synchronization system: Start stop synchronization
- Baud rates: 1200, 2400, 4800, 9600, 19,200 bps

## PC card interface

- Slot: PC card slot TYPE II
- Compatible card: ATA flash memory card
- Function specifications: Saving measurement data, saving and reading settings data

## Faulty Wiring Checking Functions

•Check details:

Presence/absence of power input; check for frequency measurement range; voltage phase sequence; presence/absence of power input; whether current clamp is reverse-connected

## Scaling Function

The VT ratio and CT ratio can be set.

- Settings ranges VT ratio: 1–10,000  
CT ratio: 1–10,000 (in increments of 0.01)

## External Control I/O (for RS-232 only; not provided for RS-485)

These input and output can be used as signals for starting and stopping integrating measurement.

- Control input: TTL level or contact
- Control output: TTL level

## Other Functions

Clock (typical precision: ±100 ppm), key lock, system reset

## General Specifications

- Environmental requirements: Indoor usage at an altitude of 2000 meters or less.
- Usage temperature and humidity ranges: 0–50°C, 5–85% RH (no condensation)
- Storage temperature and humidity ranges: -20–60°C, 90% RH (no condensation)
- Insulating resistance: 500 V DC, 50 MΩ or greater
  - Between voltage input terminals and case
  - Between voltage input terminals and current input terminals, communication terminals, and control I/O terminals
  - Between power line and case
  - Between power line and current input terminals, communication terminals, and control I/O terminals
- Insulating withstand voltage:
  - 5550 V AC for one minute
    - Between voltage input terminals and case
  - 3250 V AC for one minute
    - Between voltage input terminals and current input terminals, communication terminals, and control I/O terminals
  - 2300 V AC for one minute
    - Between power line and case
    - Between power line and current input terminals, communication terminals, and control I/O terminals
- Power supply: 100–240 V AC ±10%, 50/60 Hz
- Consumed power: 8 VA maximum
- External magnetic field effects: Within accuracy levels at 400 A/m
- External dimensions: Approximately 117×161×51 mm (W×H×D)
- Weight: Approximately 0.6 kg
- Terminals:
  - Voltage input
    - CW120: 3 terminals Banana terminals (safety terminals)
    - CW121: 4 terminals Banana terminals (safety terminals)
  - Current terminals
    - CW120: 2 pairs Banana terminals (safety terminals)
    - (H/L) CW121: 3 pairs Banana terminals (safety terminals)
  - External control I/O
    - 3 terminals (H/L/H) Screwless terminals
    - terminals RS-485 4 terminals (+/-SG/TM) M3 screw terminals
- Connectors:
  - RS-232: Mini DIN 8-pin
  - AC power supply: 2-pin
- Accessories:
  - Voltage input probes: 3 for CW120, 4 for CW121
  - Power cord, user's manual, operation guide, Toolbox (setting software)
- Safety standards:
  - Compliant with EN61010-1, EN61010-2-031
  - Voltage input line
    - Overvoltage category III (Max. input voltage : 600 Vrms)
  - Power line
    - Overvoltage category II (Max. input voltage : 264 Vrms)
  - Pollution degree 2
- EMC (emission):
  - Compliant with EN55011, Group1, ClassA; EN61326; EN61000-3-2; EN61000-3-3
- EMC (immunity):
  - Compliant with EN61326

## ● CW120/CW121 Clamp-on Power Meter Specifications

Model (Part No.)	Suffix code	Option code	Description
CW120			Three phase 3 wire
CW121			Three phase 4 wire
Power cord	-D		AC power cord (UL/CSA Standard)
	-F		AC power cord (VDE Standard)
	-R		AC power cord (SAA Standard)
	-S		AC power cord (BS Standard)
Communication	-1		RS-232 communication interface
	-2		RS-485 communication interface
Options for CW 120	/C1		Two 200 A current clamp-on probes (96030)
	/C3		Two 500 A current clamp-on probes (96031)
	/C5		Two 700 A current clamp-on probes (96032)
	/C7		Two 50 A current clamp-on probes (96033)
Options for CW 121	/C2		Three 200 A current clamp-on probes (96030)
	/C4		Three 500 A current clamp-on probes (96031)
	/C6		Three 700 A current clamp-on probes (96032)
	/C8		Three 50 A current clamp-on probes (96033)
Other options Communication (RS232)	/PM1		Main unit case, carrying case, CF pack, and 91011
Basic Package	/PB1		Main unit case, carrying case + CF pack

	Model (Part No.)	Description	
Accessories	Current clamp-on probe	96030	200 A
		96031	500 A
		96032	700 A
		96033	50 A
		96034	3000 A (large diameter type)
		96035	3000 A (flexible type)
	Power cable	98030	length 1.5 m
	Voltage probe	91007	Four per set
	Voltage probe	91018	Three per set
	Communication cable	91011	RS232 communication cable for PC (9-pin)
	Printer cable	91010	RS232 printer cable, length 1.5 m
	Printer	97010	Includes one roll of thermal paper and one battery pack
	AC adapter for printer	94006	Power Supply 200-240 VAC
	AC adapter for printer	94007	Power Supply 100-120 VAC
Printer thermal paper	97080	10 rolls	
Carrying case	93022	Holds main unit and accessories	
Main unit case	93023	Includes magnet	
CF pack (16 MB)	97030	Includes CF adapter	

## ● Accessories supplied at no extra cost

Product Name	Part Number	Qty
1. Power cord		3
2. Voltage probes (for CW 120)	91018	4
Voltage probes (for CW 121)	91017	
3. User's Manual	IMCW 120-E	1
4. Operation Guide	IMCW-120P-E	1

## ● Accessories (current clamp-on probes)

The CW120 Series cannot take measurements without accessories.  
The power clamps (96030 to 96035) and the CF pack (97030) need to be purchased separately.

Model (Part No.)	96033	96030	96031	96032	96034	96035
Power clamps						
Measurable conductor diameter	ø18 mm	ø30 mm	ø30 mm	ø65 mm	65 × 100 mm	ø170 mm
Measurement range	50 A AC	200 A AC	500 A AC	700 A AC	1000/2000/3000 A AC	300/3000 A AC
Output voltage	500 mV AC	500 mV AC	500 mV AC	250 mV AC	500 mV AC	500 mV AC
Accuracy Amplitude * Accuracy changes according to input	±0.5% of rdg ±0.1 mV	±0.5% of rdg ±0.1 mV	±0.5% of rdg ±0.1 mV	±1.0% of rdg ±0.2 mV	±1.0% of rdg	±1.0% of rdg
Phase	Within ±1.0°	Within ±0.5°	Within ±1.0°	Within ±1.0°	Within ±1.0°	Within ±1.0°
Maximum used circuit voltage	300 Vrms AC	600 Vrms AC	600 Vrms AC	600 Vrms AC	600 Vrms AC	1000 Vrms AC (pri)
Cable length	3 m	3 m	3 m	3 m	3 m	3 m
Dimensions	52×106×25 mm	73×130×30 mm	73×130×30 mm	100×172.5×32 mm	120×310×48 mm	140×64×28 mm
Weight	Approximately 220 g	Approximately 300 g	Approximately 300 g	Approximately 500 g	Approximately 1390 g	Approximately 470 g

\* Powered by 9 V battery.  
\* Specifications are subject to change without notice.

## ● Accessories

### Carrying case



93022

The CW120 main unit can be packed in the carrying case with accessories like the current clamp and voltage probe attached. The carrying case can also hold other accessories.

### Main unit case



93023

Includes magnet and stand

### Printer



97010

\* AC adapter sold separately.

### Power cable



98030

This cable supplies power from a measurement circuit.  
\*Not applied to CE and UL.

# CW140 CW140 Clamp-on Power Meter for Power Quality



- Two-system load measurements with one device
- Easy-to read LCD screen display (5.9 inches, 320×240 pixels)
- Support for variety of connection types
- Complete data management (internal memory, FDD, RS-232C)
- A wide range of application  
(instant mode, electric energy mode, demand mode, harmonics mode)
- Supports English, Spanish, French, Italian, German and Japanese display content

## Overview

The CW140 is a 3Ø4W clamp-on power meter with a number of features essential for energy conservation efforts, such as support for power factor and two-load measurements as well as PC-based data analysis. These features help reduce the labor involved in taking measurements and preparing reports.

## General Specifications

External dimensions : Approx. 206(W)×184(H)×65(D) mm

Weight : Approx. 1.2 kg (including batteries)

Power : AC adapter, six AA size alkaline dry batteries, Ni-MH (nickel-metal hydride) rechargeable battery

**YOKOGAWA**   
Yokogawa M&C Corporation

World Wide Web site at  
<http://www.yokogawa.com/MCC>

**NOTICE**

- Before using the product, read the instruction manual carefully to ensure proper and safe operation

YOKOGAWA M&C CORPORATION Musashino Center Bldg.  
International Sales Dept. 1-19-18 Nakacho, Musashino-shi, Tokyo, 180-0006 Japan  
Phone: +81-422-55-8755 Facsimile: +81-422-55-8954

YOKOGAWA CORPORATION OF AMERICA  
Phone: +1-770-253-7000 Facsimile: +1-770-251-2088

YOKOGAWA EUROPE B. V.  
Phone: +31-334-64-1611 Facsimile: +31-334-64-1610

YOKOGAWA ENGINEERING ASIA PTE. LTD.  
Phone: +65-241-9933 Facsimile: +65-241-2606

YOKOGAWA AMERICA DO SUL LTDA.  
Phone: +55-11-5681-2400  
Facsimile: +55-11-5681-1274/4434

YOKOGAWA MEASURING INSTRUMENTS  
KOREA CORPORATION  
Kangnam-ku, Seoul, KOREA  
Phone: +82-2-551-0660 to 0664 Facsimile: +82-2-551-0665

YOKOGAWA AUSTRALIA PTY. LTD.  
Phone: +61-2-9805-0699 Facsimile: +61-2-9888-1844

YOKOGAWA BLUE STAR LTD.  
Phone: +91-80-227-1513 Facsimile: +91-80-227-4270

YOKOGAWA MIDDLE EAST E.C.  
Busaiten 225, Muharrag, BAHRAIN  
Phone: +973-358100 Facsimile: +973-336100

LTD. YOKOGAWA ELECTRIC  
RUSSIAN FEDERATION  
Phone: +7-095-737-7868 Facsimile: +7-095-737-7869

Represented by:

MCK-EM9